



rescue
environmentally
responsible products

Deluxe
**downspout diverter
& connector kit**

create your own rainwater collection system

Installation Guide

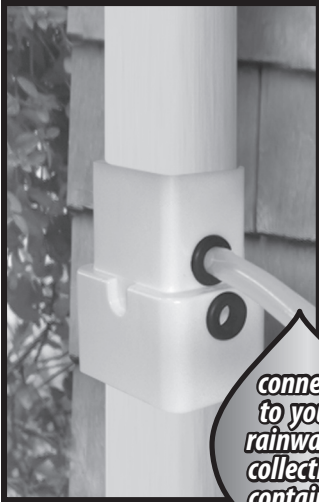

*connect
to your
rainwater
collection
container*

- easy to install / convenient to use
- fits 2" x 3" or 3" x 4" standard downspout
- collect rainwater for use in garden or other outdoor uses
- save money while conserving the environment

Convenient downspout water diverter channels rainwater from the downspout to the water collection reservoir and eliminates reservoir overflow.

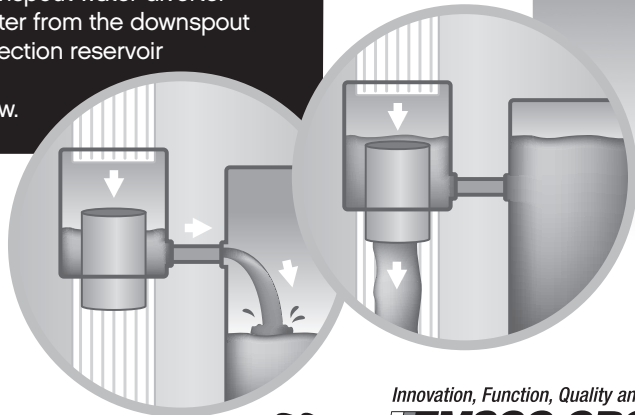

Innovation, Function, Quality and Service

EMSCO GROUP

Girard, PA 16417

www.emscogroup.com

parts included

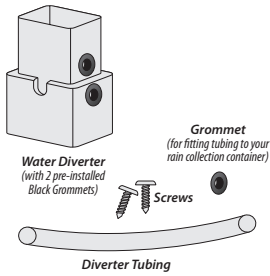

tools and supplies needed

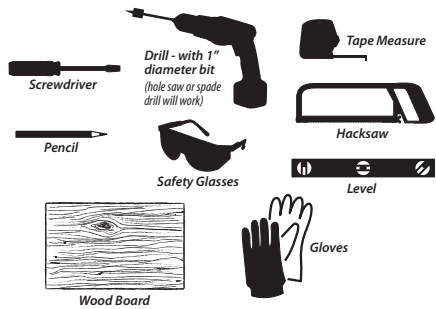

IMPORTANT – Read these safety warnings carefully before installation.

Please read through all instructions before beginning the installation of your new Rescue™ Deluxe Downspout Diverter & Connector Kit. Improper installation, usage and maintenance may cause damage to your home/property or possible injury and/or death. Emco Group is not responsible for any damages or injuries caused as a result of or by improper installation.

As of 3/1/2009, the state of Colorado does not allow the use of rainwater collection systems.
Check your local ordinances for restrictions in using any rainwater collection device.



CAUTION – WARNING – HAZARDS



DURING INSTALLATION AND SET UP

Installation Hazards – Rain barrels are for water collection and outdoor use only. No other uses are recommended. Downspout edges may be sharp. Wear protective gloves when cutting and handling downspouts to avoid cuts or scratches. Always wear safety glasses when doing cutting or drilling to prevent eye injuries. Protect the home's siding with a sheet of wood inserted between the downspout and the siding to prevent damage.

Electrical Hazard – If downspout contains heating cables, there is a potential electrocution or fire hazard during installation, which may cause serious injury or death.

DURING USE

Drowning Hazard – Children should NEVER be allowed to play on or near, to climb on or to open your rain barrel. Take the following steps to avoid accidental drowning: ALWAYS keep your rain barrel cover securely attached and closed. NEVER use your rain barrel if the cover is cracked, warped, broken or damaged in any way and cannot be securely attached and closed. If the cover cannot be securely attached, empty rain barrel and do not use. NEVER position rain barrel near a deck, stairs, chair, or other structures or items that would allow a child to climb above, onto or into your rain barrel.

Water Contamination Hazard – Drinking water from a rain barrel may cause serious illness or death. DO NOT let people (or animals) drink water from a rain barrel. Water in rain barrel may become stagnant or contaminated. Use rain barrel water only for watering plants or outdoor cleaning uses. DO NOT use for cooking, washing or in any way that may result in ingestion of the water.

Tipping Hazard – If not properly set up, accidental tipping of your rain barrel may occur causing personal injury or property damage. Preparing the area where your rain barrel will be placed is important. It must be level and provide solid support. DO NOT place rain barrel on any surface that is not flat and even. Always use a solid surface under your rain barrel.

CAUTION: Always wear safety glasses when cutting or drilling to prevent eye injuries. Downspout edges may be sharp. Wear gloves to protect against cuts or scratches.

WARNING: If your downspouts and/or gutters contain heating cables, there is potential for electrocution or fire hazard during installation.

1 Attaching the water diverter tubing to the downspout and rain barrel

Choose the proper orientation of the water diverter. The diverter is to be installed on standard 2"x3" downspout with the *narrow end* facing up — or — on oversized 3"x4" downspout with the *wide end* facing up. Once you have determined which downspout size you have and thus which end of the diverter faces upward (keeping the diverter tubing holes facing the barrel), push diverter tubing into the top hole on the diverter. Insert just the end of the tubing so it extends into the diverter no more than 1/4".

2 Locating position of diverter on downspout

For proper operation, the water diverter must be installed at a position on the downspout enabling the connector hose to be level. The water outlet hole in the diverter and the water inlet hole in your water collection container should be level so that the tubing is level between the two holes. Refer to illustrations.

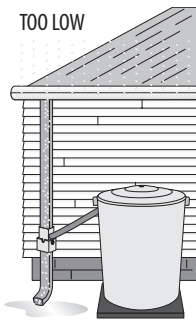

When the diverter is installed *too low* in relation to the rain barrel tubing connector, your rain barrel will not fill with water.

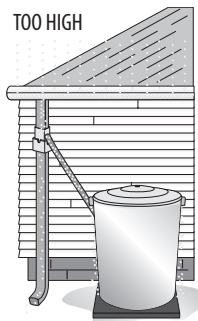

When the diverter is installed *too high* in relation to the rain barrel tubing connector, your rain barrel will overflow and overflow.

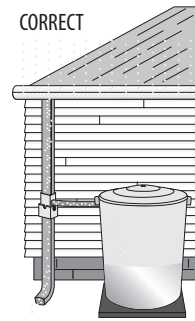

When the diverter is installed level in relation to the rain barrel tubing connector, your rain barrel will fill and excess water will be directed back down your home's downspout.

3 Marking and cutting downspout for diverter installation

- 1 Extend the diverter assembly so it is touching the downspout. Using a level, confirm the tubing is level.
- 2 Make a pencil mark on the downspout indicating the top of the diverter.
- 3 Using a tape measure, measure 2" below that mark and make a second mark.
- 4 Remove the downspout bracket below your installation marks to loosen the downspout from your house (keep bracket handy as you will be reinstalling later). This will provide some clearance between the downspout and house to allow for cutting downspout. Connections may vary. A slotted or Phillips screwdriver or a socket wrench may be needed.

TIP: Place a scrap piece of plywood or cardboard between the house and the downspout before cutting to protect your home's siding. If a second cut is necessary, place the downspout and scrap wood on ground or work surface for easier cutting.

Continued on back.

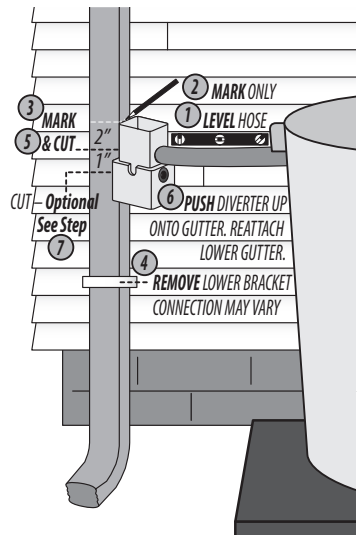

3 Marking and cutting downspout for diverter installation *CONTINUED*

- Using a hacksaw, cut the downspout at the **second** pencil mark you made. After this cut is complete, remove the bottom piece of downspout from the house.
- Push the diverter UP onto the cut end of the downspout leading from the gutter above. You may need to flex the downspout slightly in order to get the diverter onto the downspout. Wear gloves to protect your hands from scratches or cuts. Push the diverter all the way onto the downspout until it stops.
- Attaching the diverter kit will add 1" to the total length of your downspout. If there is not enough space to reattach the bottom section of the downspout to the bottom of the diverter, then you will need to make an additional cut at the top of the lower downspout section. Begin by cutting and removing 1" from the top of the lower downspout section until it can be replaced in its original position. Discard the 1" piece of downspout you cut off and reattach the lower downspout section to its original position.

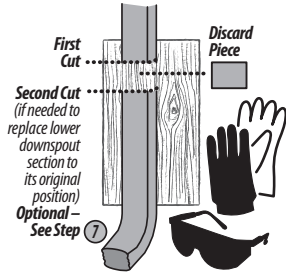

4 Attaching the water diverter assembly to the downspout

After you slide the lower portion of the downspout up into/onto the bottom portion of the water diverter, remove the wood or cardboard protecting your siding. The enclosed locking screws attach both the top and bottom sections of downspout to the diverter for a more secure connection. When the diverter is in place and both downspout sections are now connected to the diverter, you can reattach the lower downspout bracket you removed earlier and secure the downspout to your house. (See illustrations below)

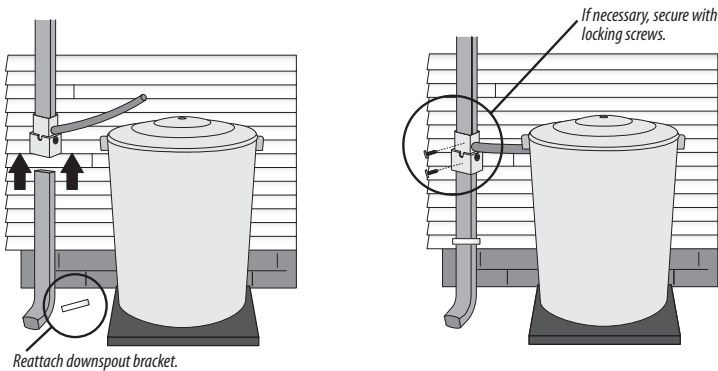

Be sure to ask about other EMSCO Rainwater Collection Systems such as our 60-Gallon Rain Barrel or our WaterStones™ – a 40-gallon rainwater collection system with a natural rock appearance. These complete systems include the diverter kit and all necessary connections.

Innovation, Function, Quality and Service

EMSCO GROUP

Girard, PA 16417

www.emscogroup.com

